

BD

**Atraumatische Klemmen
Atraumatic Forceps
Pincès atraumatique
Pinzas atraumático
Pinze atraumatico**



BD

BD

Atraumatische Gefäßklemmen
Atraumatic Hemostatic Forceps
Pincès hémostatiques atraumatiques
Pinzas hemostáticas atraumáticas
Pinze emostatiche atraumatiche



cm — HALSTEAD-MOSQUITO —
12,0 **BD-800-12** **BD-801-12**
15,0 **BD-800-15** **BD-801-15**

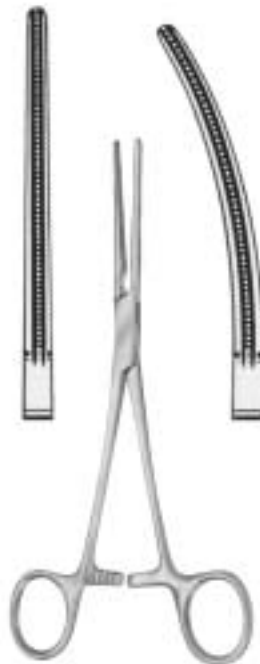

cm — PEAN —
14,0 **BD-802-14** **BD-803-14**
16,0 **BD-802-16** **BD-803-16**
18,0 **BD-802-18** **BD-803-18**
20,0 **BD-802-20** **BD-803-20**



cm — RANKIN —
16,0 **BD-804-16** **BD-805-16**



cm — DE BAKEY —
12,0 **BD-012-12** **BD-013-12**



DE BAKEY
BD-111-12
12,0 cm



DE BAKEY
BD-113-12
12,0 cm



DE BAKEY
BD-211-12
12,0 cm

Atraumatische Gefäßklemmen
Atraumatic Hemostatic Forceps
Pincès hémostatiques atraumatiques
Pinzas hemostáticas atraumáticas
Pinze emostatiche atraumatiche

BD



cm	LEES
23,0	BD-311-23
25,0	BD-311-25



BD-311-25

BD-311-23

Bronchusklemmen
Bronchus Forceps
Pincès-Clamps à Bronches
Pinzas clamps bronquiales
Pinze per bronchi



LEES
BD-313-25
25,0 cm

BD

Atraumatische Gefäßklemmen
Atraumatic Hemostatic Forceps
Pincès hémostatiques atraumatiques
Pinzas hemostáticas atraumáticas
Pinze emostatiche atraumatiche

Coarctationsklemmen
Coarction Clamps
Pincès à coarctacion
Pinzas para coarctación
Pinze per coartazione

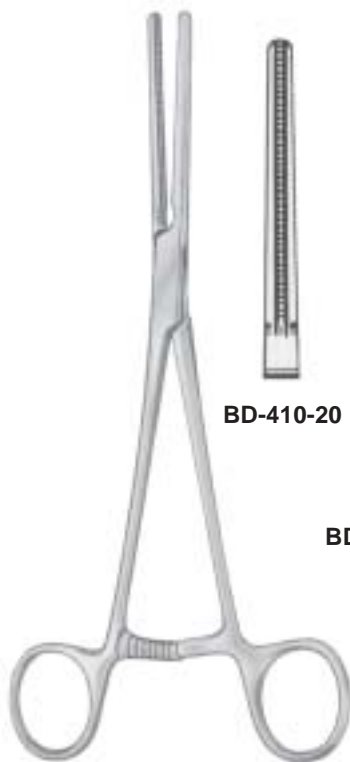

BD-410-20

BD-410-22

BD-410-26

cm	POTTS
20,0	BD-410-20
22,5	BD-410-22
26,0	BD-410-26

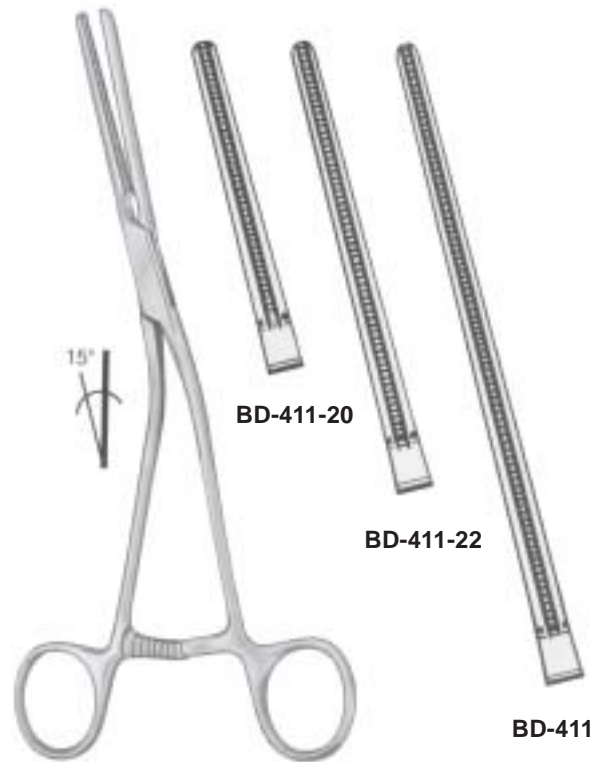

BD-411-20

BD-411-22

BD-411-26

cm	GLOVER
20,0	BD-411-20
22,5	BD-411-22
26,0	BD-411-26

Anastomosenklemmen
 Anastomosis Clamps
 Pincès à anastomose
 Pinzas para anastomosis
 Pinze per anastomosi



cm POTT'S / GLOVER
 21,0 **BD-511-21**
 24,0 **BD-511-24**



BD-511-21



BD-511-24



cm GLOVER
 18,0 **BD-513-18**
 22,0 **BD-513-22**



BD-513-18



BD-513-22

BD

Atraumatische Gefäßklemmen
Atraumatic Hemostatic Forceps
Pincés hémostatiques atraumatiques
Pinzas hemostáticas atraumáticas
Pinze emostatiche atraumatiche

Vascularklemme löffelförmig
Vascular Clamps Spoon Shaped
Pince vasculaire forme cuiller
Pinza vascular forma cuchara
Pinza vascolare forma cucchiaio



BD-611-21



BD-611-26

cm	GLOVER
21,0	BD-611-21
26,0	BD-611-26

Peripher-Vascularklemmen
Peripheral Vascular Forceps
Pincés vasculaires périph.
Pinzas vasculares perif.
Pinze vascolari perif.



BD-710-19

BD-710-22

cm	DE BAKEY
18,0	BD-710-19
22,0	BD-710-22

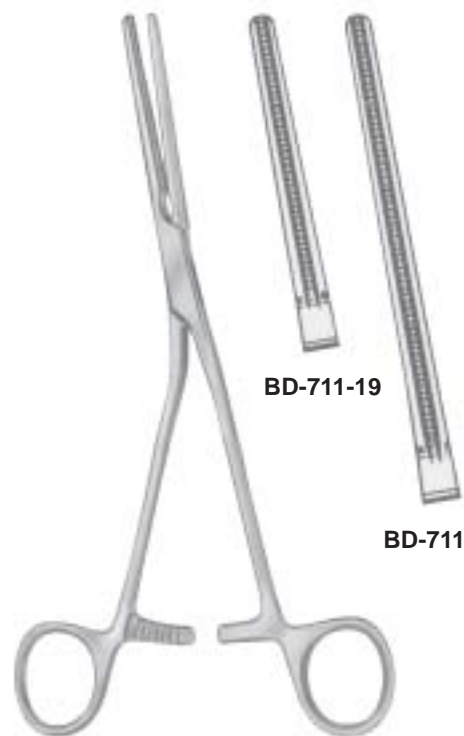

BD-711-19

BD-711-22

cm	DE BAKEY
18,0	BD-711-19
22,0	BD-711-22

Atraumatische Mehrweckklemmen
 Atraumatic Multi-Purpose Clamps
 Pincès-clamps polyvalentes
 Pinzas clamps para usos varios
 Pinze atraumatiche per diversi usi



DARDIK



cm	0°	15°	30°	45°	90°
14,0	--	--	--	--	BD-712-90
15,0	BD-712-00	BD-712-15	BD-712-30	BD-712-45	--

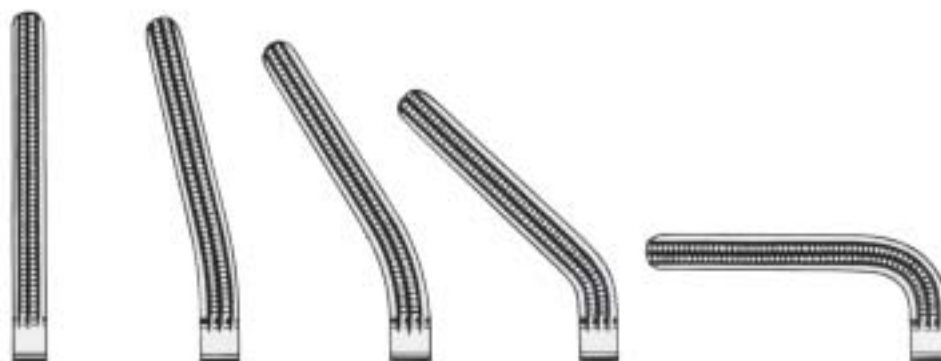

cm	0°	15°	30°	45°	90°
16,0	--	--	--	--	BD-714-90
17,0	BD-714-00	BD-714-15	BD-714-30	BD-714-45	--

BD

Atraumatische Gefäßklemmen
Atraumatic Hemostatic Forceps
Pincès hémostatiques atraumatiques
Pinzas hemostáticas atraumáticas
Pinze emostatiche atraumatiche

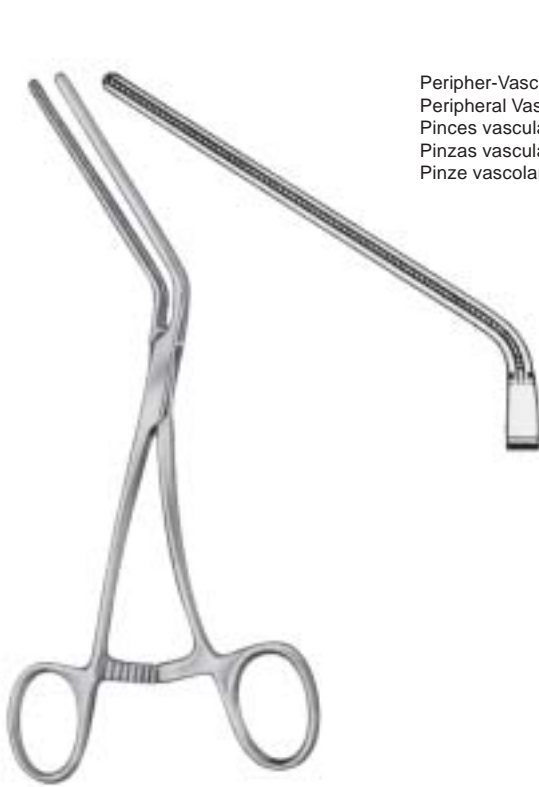

LELAND-JONES
BD-811-19
19,0 cm

Peripher-Vascularklemmen
Peripheral Vascular Forceps
Pincès vasculaires périph.
Pinzas vasculares perif.
Pinze vascolari perif.



DE BAKEY
BD-811-26
26,0 cm



cm DE BAKEY
19,0 **BD-813-19**
20,0 **BD-813-20**



BD-813-19

BD-813-20



DE BAKEY
BD-911-16
16,0 cm



BAINBRIDGE



BD-916-15
15,0 cm



BD-916-18
18,0 cm



BD-917-15
15,0 cm



BD-917-18
18,0 cm

Peripher-Vascularklemmen
 Peripheral Vascular Forceps
 Pincès vasculaires périph.
 Pinzas vasculares perif.
 Pinze vascolari perif.



LELAND JONES
BD-022-19
19,0 cm



BD-023-19
19,0 cm

BD-025-19
19,0 cm

LELAND JONES

Aortaklemmen
Aortic Clamp
Pince-clamp à aorte
Pinza clamp para aorta
Pinza per aorta



LIDDLE
BD-029-27
27,0 cm

Aorta-Anastomosenklemmen
Aorta-Anastomosis Clamps
Pinces-clamps pour anastomoses d'aorte
Pinzas clamps para anastomosis de aorta
Pinze aortiche



LAMBERT KAY
BD-121-20
20,0 cm

Iliaca-Klemme
Iliac Clamp
Pince-clamp à iliaque
Pinza clamp para iliaca
Pinza per iliaca



LAMBERT KAY
BD-123-20
20,0 cm



DE BAKEY
BD-125-20
20,0 cm

BD

Atraumatische Gefäßklemmen
Atraumatic Hemostatic Forceps
Pinces hémostatiques atraumatiques
Pinzas hemostáticas atraumáticas
Pinze emostatiche atraumatiche



links gebogen
curved to left
courbe à gauche
curva a la izquierda
curva a sinistra



WEBER
BD-127-26
26,0 cm



rechts gebogen
curved to right
courbe à droite
curva a la derecha
curva a destra



WEBER
BD-129-26
26,0 cm

Aorta-Aneurysma-Klemmen
Aorta-Aneurysm Clamps
Pincés-clamps pour aneurysme d'aorte
Pinzas clamps para aneurisma de aorta
Pinze per aneurisma di aorta



DE BAKEY

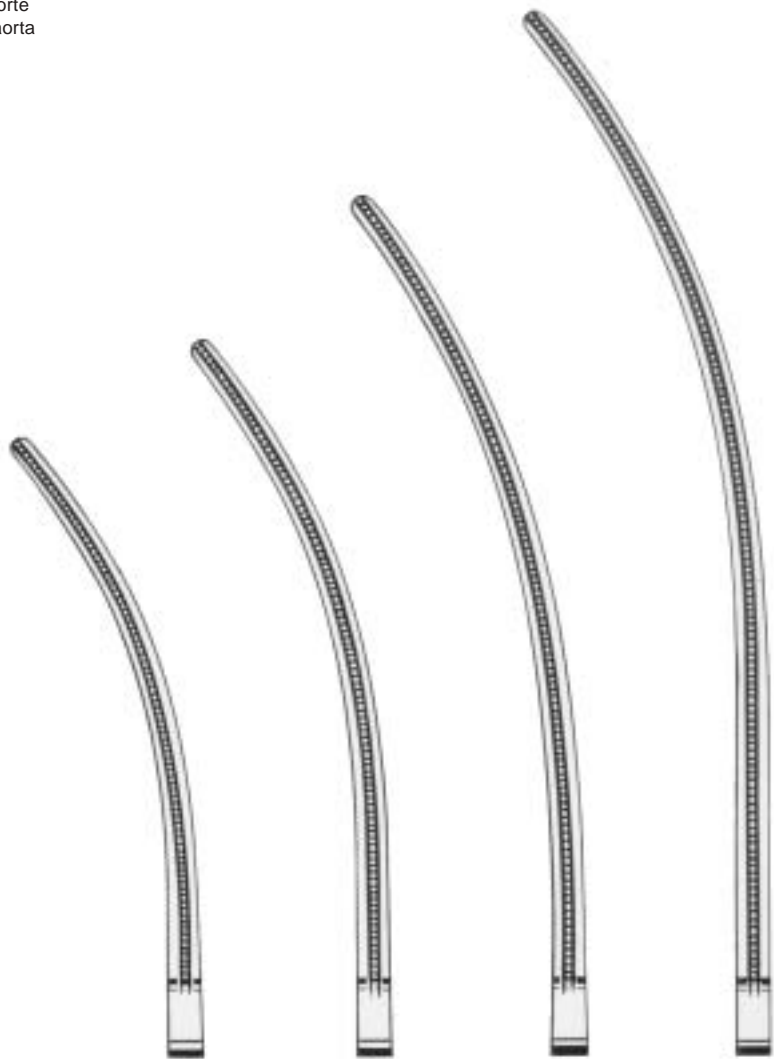

BD-221-24
24,0 cm

BD-221-27
27,0 cm

BD-221-31
31,0 cm

BD-221-35
35,0 cm

BD

Atraumatische Gefäßklemmen
Atraumatic Hemostatic Forceps
Pinces hémostatiques atraumatiques
Pinzas hemostáticas atraumáticas
Pinze emostatiche atraumatiche

Aorta-Aneurysma-Klemmen
Aorta-Aneurysm Clamps
Pinces-clamps pour aneurysme d'aorte
Pinzas clamps para aneurisma de aorta
Pinze per aneurisma di aorta



DE BAKEY BAHNSON



BD-223-24
24,0 cm

BD-223-25
25,0 cm

BD-223-26
26,0 cm

Aorta-Aneurysma-Klemmen
Aorta-Aneurysm Clamps
Pincés-clamps pour aneurysme d'aorte
Pinzas clamps para aneurisma de aorta
Pinze per aneurisma di aorta



DE BAKEY
BD-225-28
28,0 cm



DE BAKEY
BD-227-28
28,0 cm

BD

Atraumatische Gefäßklemmen
Atraumatic Hemostatic Forceps
Pinces hémostatiques atraumatiques
Pinzas hemostáticas atraumáticas
Pinze emostatiche atraumatiche

Atraumatische Mehrzweckklemmen
Atraumatic Multi-Purpose Clamps
Pinces-clamps polyvalentes
Pinzas clamps para usos varios
Pinze atraumatiche per diversi usi



DE BAKEY MORRIS

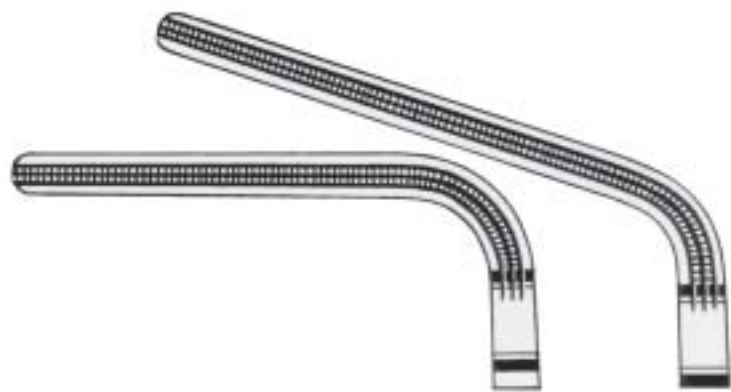

BD-229-18
18,0 cm

BD-229-20
20,0 cm



BD-229-23
23,0 cm

BD-229-25
25,0 cm

Atraumatische Gefäßklemmen
Atraumatic Hemostatic Forceps
Pincés hémostatiques atraumatiques
Pinzas hemostáticas atraumáticas
Pinze emostatiche atraumatiche

BD

Atraumatische Mehrzweckklemmen
Atraumatic Multi-Purpose Clamps
Pincés-clamps polyvalentes
Pinzas clamps para usos varios
Pinze atraumatiche per diversi usi



DE BAKEY



BD-231-18
18,0 cm

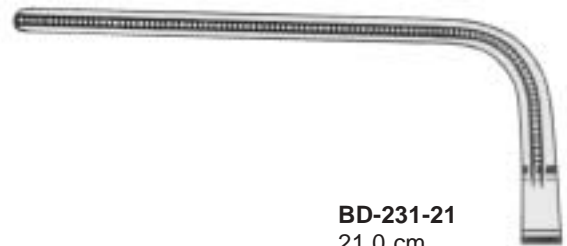

BD-231-21
21,0 cm



BD-231-23
23,0 cm

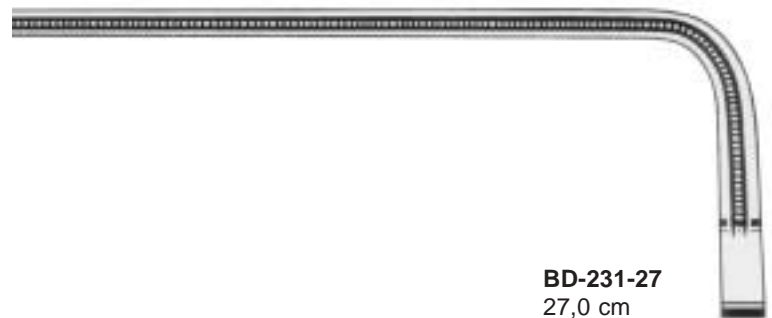

BD-231-27
27,0 cm

BD

Atraumatische Gefäßklemmen
Atraumatic Hemostatic Forceps
Pincés hémostatiques atraumatiques
Pinzas hemostáticas atraumáticas
Pinze emostatiche atraumatiche

Aorta-Aneurysma-Klemmen
Aorta-Aneurysm Clamps
Pincés-clamps pour aneurysme d'aorte
Pinzas clamps para aneurisma de aorta
Pinze per aneurisma di aorta



DE BAKKEY



BD-421-25
25,0 cm

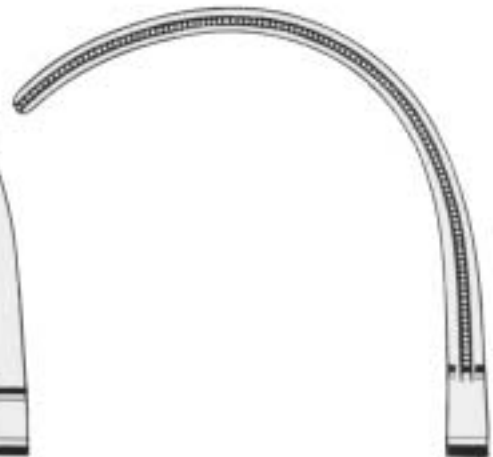

BD-421-26
26,0 cm

Bronchus-Klemmen
Bronchus Clamps
Pincès pour les bronches
Pinzas bronquiales
Pinze per bronchi



DE BAKEY
BD-427-27
27,0 cm

BD

Atraumatische Gefäßklemmen
Atraumatic Hemostatic Forceps
Pinces hémostatiques atraumatiques
Pinzas hemostáticas atraumáticas
Pinze emostatiche atraumatiche



DE BAKEY

BD-521-20
20,0 cm

BD-521-24
24,0 cm

BD-521-25
25,0 cm

BD-521-30
30,0 cm

Atraumatische Mehrzweckklemmen
Atraumatic Multi-Purpose Clamps
Pinces-clamps polyvalentes
Pinzas clamps para usos varios
Pinze atraumatiche per diversi usi

BD-523-20
20,0 cm

BD-523-24
24,0 cm

BD-523-25
25,0 cm

BD-523-26
26,0 cm

BD-523-27
27,0 cm

SATINSKY

Anlegezange für Clips
 Applying for Clips
 Appicateur pour clips
 Pinza para aplicar clips
 Applicatore per clips



EDWARDS
BD-528-00

Clips
 Clips
 Clips
 Clips
 Clips



mm	EDWARDS
6	BD-528-06
12	BD-528-12



WYLIE



BD-529-01
 Fig. 1
 21,0 cm



BD-529-02
 Fig. 2
 22,0 cm

BD

Atraumatische Gefäßklemmen
Atraumatic Hemostatic Forceps
Pincas hémostatiques atraumatiques
Pinzas hemostáticas atraumáticas
Pinze emostatiche atraumatiche



DE BAKAY

Atraumatische Mehrzweckklemmen
Atraumatic Multi-Purpose Clamps
Pincas-clamps polyvalentes
Pinzas clamps para usos varios
Pinze atraumatiche per diversi usi

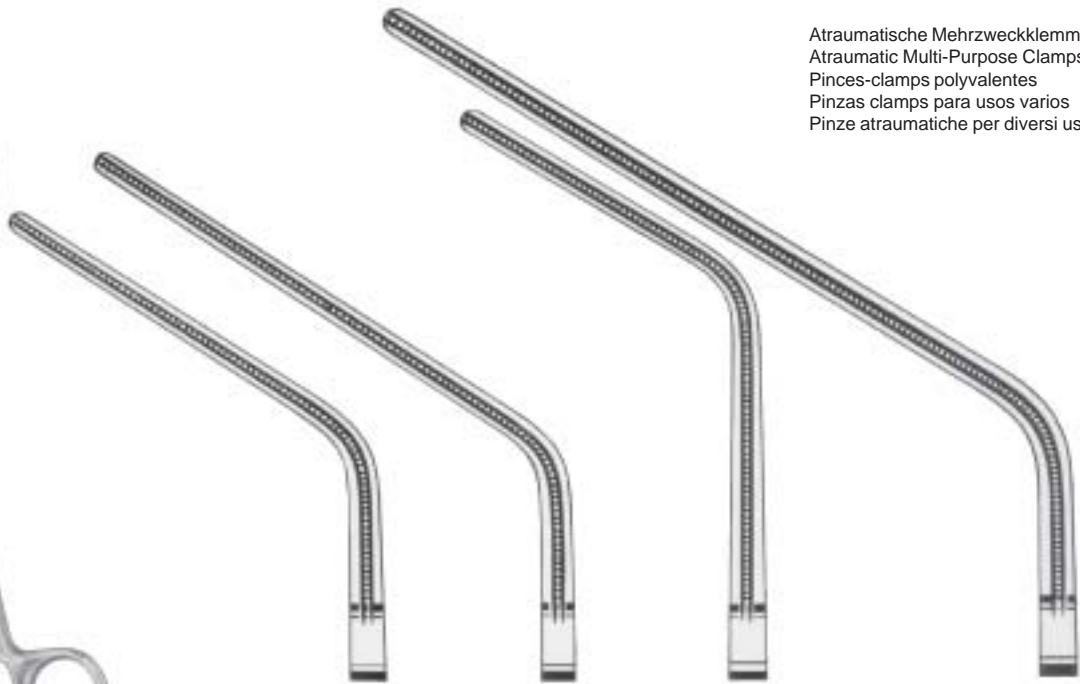

BD-521-20
20,0 cm

BD-521-24
24,0 cm

BD-521-25
25,0 cm

BD-521-30
30,0 cm



SATINSKY

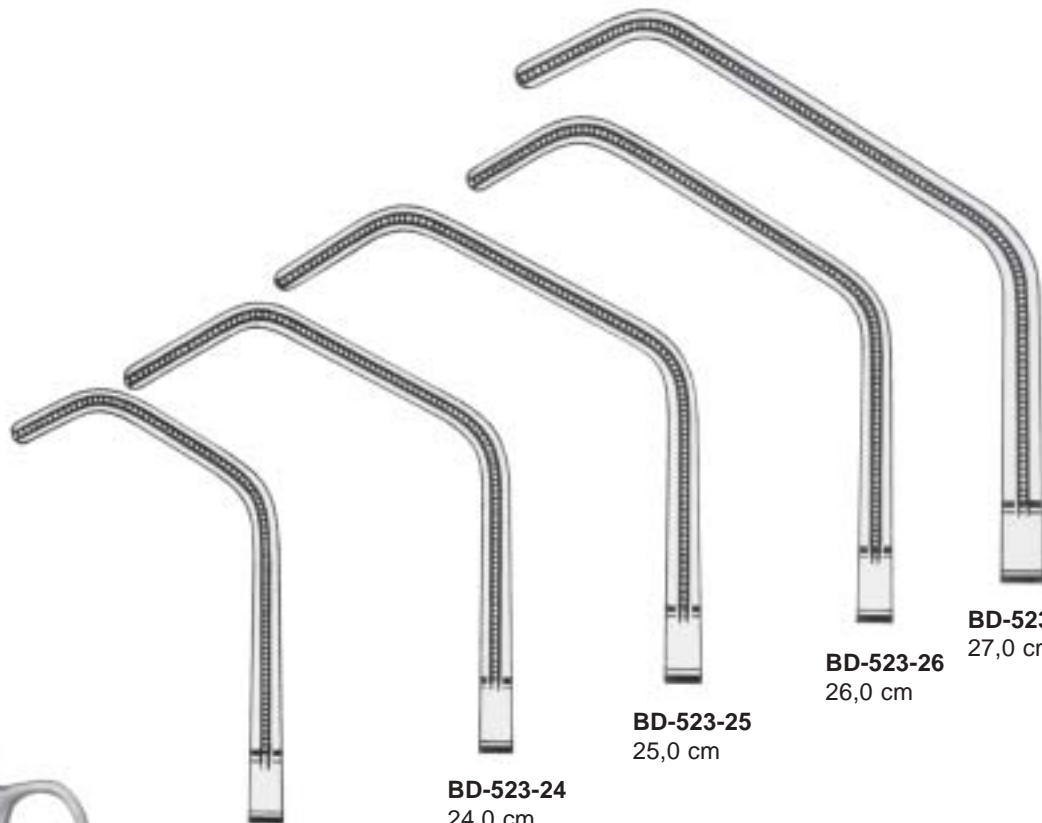

BD-523-20
20,0 cm

BD-523-24
24,0 cm

BD-523-25
25,0 cm

BD-523-26
26,0 cm

BD-523-27
27,0 cm

Aurikelklemmen
Auricle Clamps
Pincès auriculaires
Pinzas para aurícula
Pinze ventricolari



HARKEN



BD-623-25
Fig. 1
25,0 cm



BD-625-24
Fig. 2
24,0 cm



BD-627-24
Fig. 3
24,0 cm



BD-629-24
Fig. 4
24,0 cm

BD

Atraumatische Gefäßklemmen
Atraumatic Hemostatic Forceps
Pinces hémostatiques atraumatiques
Pinzas hemostáticas atraumáticas
Pinze emostatiche atraumatiche

Peripheal-Gefäßklemmen
Peripheal Vascular Clamps
Pinces-clamps, vasculaires périphériques
Pinzas para vasos periféricos
Pinze vascolari periferali



DALE
BD-721-18
18,0 cm



DALE



BD-723-17
17,0 cm



BD-723-18
18,0 cm



BD-723-19
19,0 cm



DE BAKEY
BD-821-17
17,0 cm



BECK
BD-823-17
17,0 cm

Präparier- und Ligaturklemmen
Dissecting and Ligature Clamps
Pincas à dissection et passe-fil
Pinzas de disección y para ligaduras
Pinze per dissezione e per legature



DE BAKEY
BD-825-24
24,0 cm



DE BAKEY
BD-827-24
24,0 cm

BD

Atraumatische Gefäßklemmen
Atraumatic Hemostatic Forceps
Pinces hémostatiques atraumatiques
Pinzas hemostáticas atraumáticas
Pinze emostatiche atraumatiche

Atraumatische Mehrzweckklemmen
Atraumatic Multi-Purpose Clamps
Pinces-clamps polyvalentes
Pinzas clamps para usos varios
Pinze atraumatiche per diversi usi



POTTS



BD-828-21
21,0 cm



BD-828-23
23,0 cm



BD-828-27
27,0 cm



BD-828-31
31,0 cm

Atraumatische Mehrzweckklemmen
Atraumatic Multi-Purpose Clamps
Pincés-clamps polyvalentes
Pinzas clamps para usos varios
Pinze atraumatiche per diversi usi



POTTS

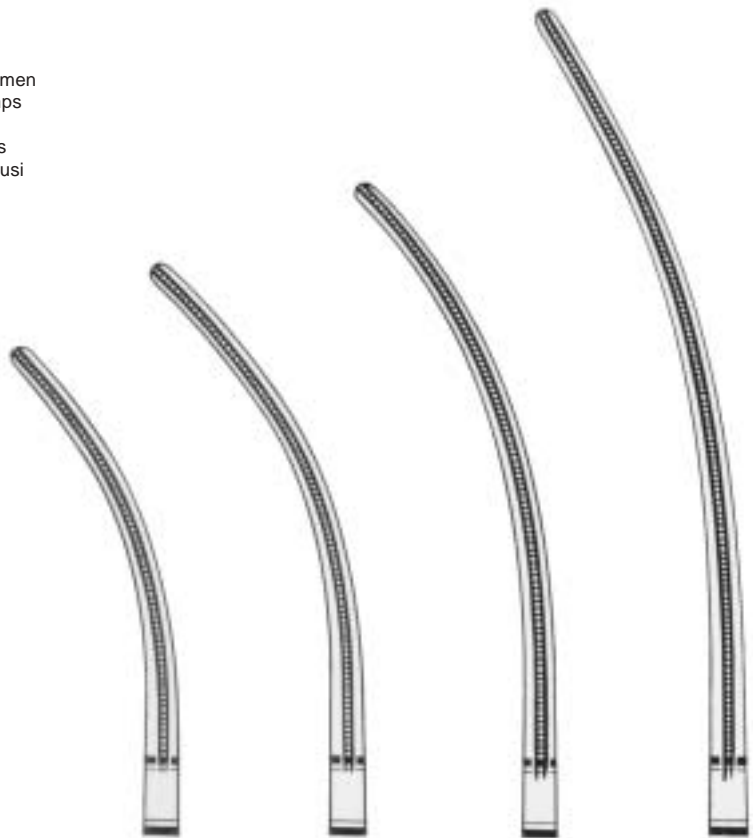

BD-829-21
21,0 cm

BD-829-23
23,0 cm

BD-829-27
27,0 cm

BD-829-31
31,0 cm

Anastomosenklemmen, Kindergrößen
Anastomosis Clamps, Pediatric
Pincès à anastomose, pédiatriques
Pinzas para anastomosis, pediátricas
Pinze per anastomosi, pediatriche



DERRA



BD-921-16
16,0 cm

BD-921-17
17,0 cm

BD-921-18
18,0 cm



DE BAKEY
BD-032-16
16,0 cm

Atraumatische Mehrzweckklemmen
Atraumatic Multi-Purpose Clamps
Pincès-clamps polyvalentes
Pinzas clamps para usos varios
Pinze atraumatiche per diversi usi



DE BAKEY
BD-032-17
17,0 cm



DE BAKEY
BD-033-15
15,0 cm



DE BAKEY
BD-037-17
17,0 cm



BD-039-17
17,0 cm

BD-039-16
16,0 cm

DE BAKEY

BD

Atraumatische Gefäßklemmen
Atraumatic Hemostatic Forceps
Pincès hémostatiques atraumatiques
Pinzas hemostáticas atraumáticas
Pinze emostatiche atraumatiche

Atraumatische Mehrzweckklemmen
Atraumatic Multi-Purpose Clamps
Pincès-clamps polyvalentes
Pinzas clamps para usos varios
Pinze atraumatiche per diversi usi



DE BAKEY



BD-131-14
14,0 cm



BD-131-15
15,0 cm



BD-131-16
16,0 cm



GLOVER
BD-231-17
17,0 cm

Anastomosenklemmen
Anastomosis Clamps
Pincès à anastomose
Pinzas para anastomosis
Pinze per anastomosi



DE BAKEY REYNOLDS



BD-239-01
Fig. 1
17,5 cm



BD-239-02
Fig. 2
17,5 cm



BD-239-03
Fig. 3
16,5 cm



BD-239-04
Fig. 3
16,5 cm



SUBRAMANIAN
BD-331-15
15,0 cm



SUBRAMANIAN
BD-333-16
16,0 cm



SUBRAMANIAN
BD-335-16
16,0 cm



OCHSNER
BD-337-23
23,0 cm

Aortaklemmen
Aortic Clamp
Pince-clamp à aorte
Pinza clamp para aorta
Pinza per aorta



DIETRICH
BD-339-21
21,0 cm

Präparier- und Ligaturklemmen
Dissecting and Ligature Clamps
Pincas à dissection et passe-fil
Pinzas de dissección y para ligaduras
Pinze per dissezione e per legature



DE BAKEY



BD-431-19
19,0 cm



BD-431-20
20,0 cm



BD-431-23
23,0 cm

Carotis-Shuntklemmen
Carotid Shunt Clamps
Pincas pour carotide
Pinzas para shunt carótido
Pinze carotis



JAVID
BD-433-18
18,0 cm



JAVID
BD-433-19
19,0 cm

Profunda-Klemmen
 Profunda Clamps
 Pincès-clamps pour profunda
 Pinzas clamps para profunda
 Pinze per profunda



GREGORY

BD-439-14
14,0 cm



BD-439-16
16,0 cm



BD-439-18
18,0 cm

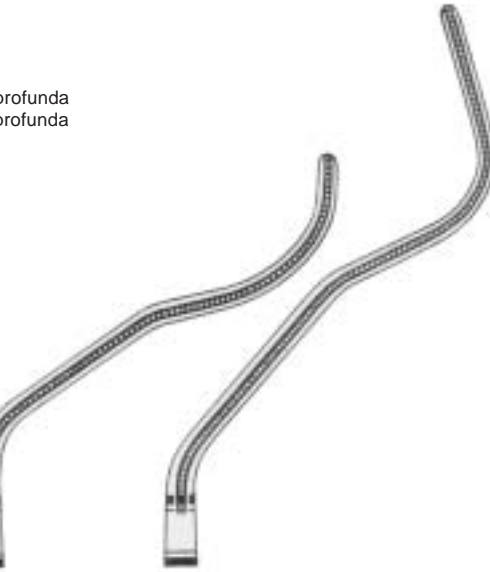

cm — COOLEY —
 13,0 **BD-530-13** **BD-531-13**



COOLEY
BD-533-13
 13,5 cm



COOLEY
BD-535-13
 13,0 cm



COOLEY
BD-537-12
12,5 cm



COOLEY
BD-539-10
10,5 cm



COOLEY
BD-631-12
12,0 cm



COOLEY
BD-633-13
13,5 cm

Atraumatische Gefäßklemmen
 Atraumatic Hemostatic Forceps
 Pincas hémostatiques atraumatiques
 Pinzas hemostáticas atraumáticas
 Pinze emostatiche atraumatiche

BD



Fr./Charrière	COOLEY
24	BD-731-24
26	BD-731-26
28	BD-731-28
30	BD-733-30
32	BD-733-32
36	BD-733-36



cm	— COOLEY —
14,0	BD-736-14 BD-737-14
16,0	BD-736-16 BD-737-16



COOLEY
BD-739-14
 14,0 cm



COOLEY
BD-830-14
 14,0 cm



COOLEY
BD-831-14
 14,0 cm

BD

Atraumatische Gefäßklemmen
Atraumatic Hemostatic Forceps
Pinces hémostatiques atraumatiques
Pinzas hemostáticas atraumáticas
Pinze emostatiche atraumatiche



COOLEY
BD-045-27
27,0 cm



COOLEY
BD-140-17
17,0 cm



BD

Atraumatische Gefäßklemmen
Atraumatic Hemostatic Forceps
Pincas hémostatiques atraumatiques
Pinzas hemostáticas atraumáticas
Pinze emostatiche atraumatiche



cm
14,0 **BD-240-14** **BD-241-14**



COOLEY
BD-243-14
14,0 cm



COOLEY
BD-245-14
14,0 cm

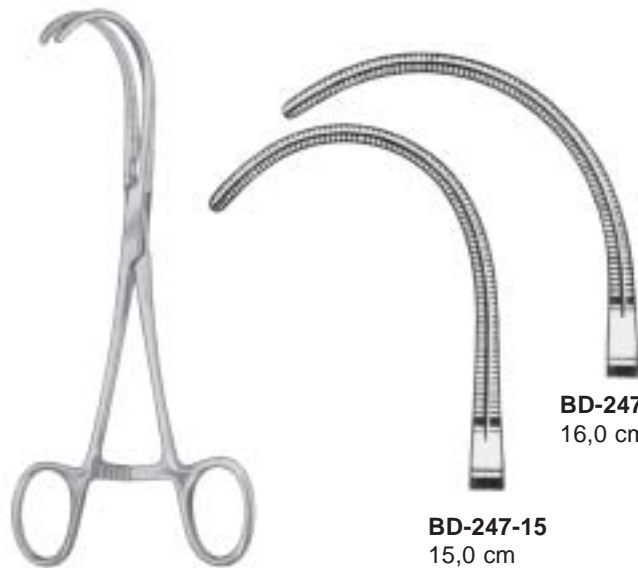

BD-247-15
15,0 cm

BD-247-16
16,0 cm

COOLEY

Atraumatische Mehrzweckklemmen
 Atraumatic Multi-Purpose Clamps
 Pincès-clamps polyvalentes
 Pinzas clamps para usos varios
 Pinze atraumatiche per diversi usi



BD-141-17
17,0 cm

BD-143-17
17,0 cm

BD-146-17
17,0 cm

COOLEY

Iliaca-Klemmen
 Iliac Clamps
 Pincès-clamps à iliaque
 Pinzas clamps para iliaca
 Pinze per iliaca

Anastomosenklemmen
 Anastomosis Clamps
 Pincès à anastomose
 Pinzas para anastomosis
 Pinze per anastomosi



COOLEY
BD-147-21
 21,5 cm

COOLEY
BD-149-17
 17,0 cm

Anastomosenklemmen
Anastomosis Clamps
Pincès à anastomose
Pinzas para anastomosis
Pinze per anastomosi



COOLEY
17,0 cm



BD-449-17
Fig. 2

BD-447-17
Fig. 1

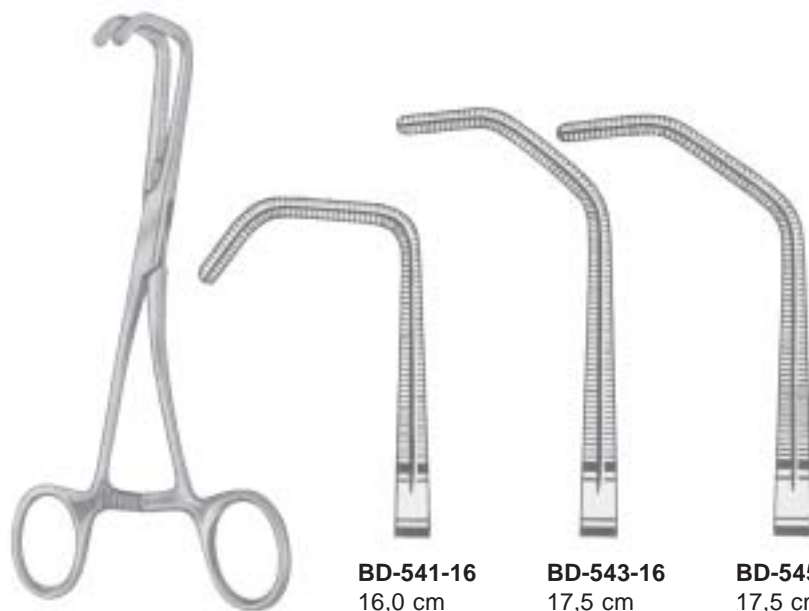

COOLEY

BD-541-16
16,0 cm

BD-543-16
17,5 cm

BD-545-17
17,5 cm

Atraumatische Gefäßklemmen
Atraumatic Hemostatic Forceps
Pincas hémostatiques atraumatiques
Pinzas hemostáticas atraumáticas
Pinze emostatiche atraumatiche

BD



COOLEY
BD-547-17
17,0 cm



COOLEY
BD-641-17
17,0 cm



COOLEY
BD-645-18
18,0 cm



COOLEY
BD-645-19
19,0 cm



COOLEY
BD-645-26
26,0 cm



COOLEY
BD-647-27
27,0 cm

Neonatal- und Kinderklemmen, extra feine Modelle
Neonatal and Childrens Clamps, extra delicate patterns
Pincas-clamps pour des nouveaux-nés et des enfants, modèles très fins
Pinzas clamps para recién nacidos y niños, modelos muy finos
Pinze pediatriche, modelli molto fini

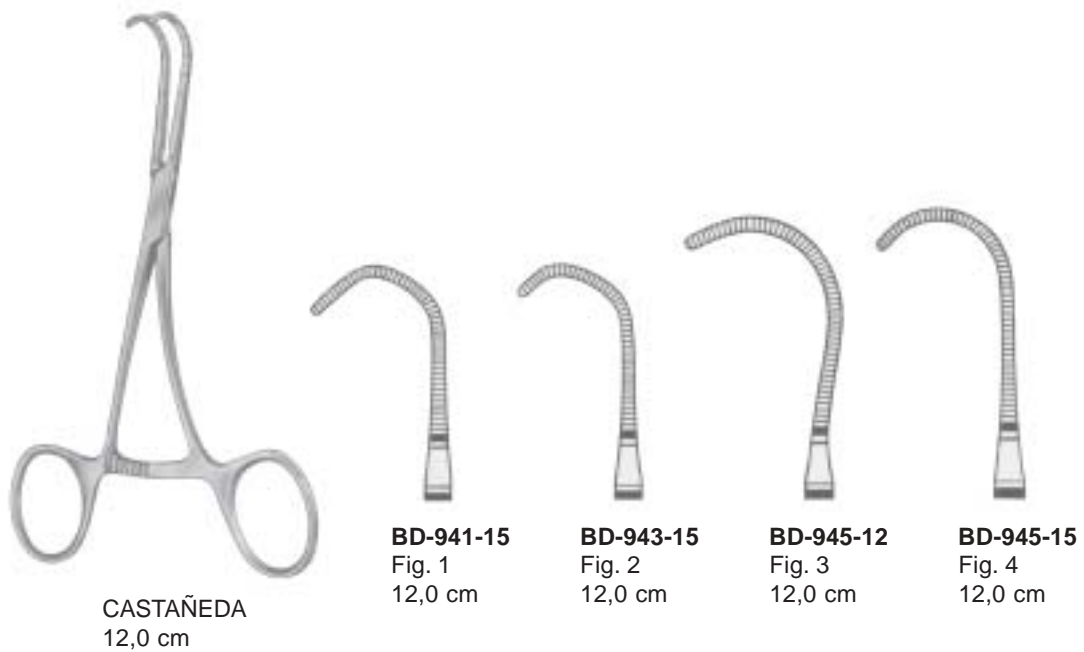
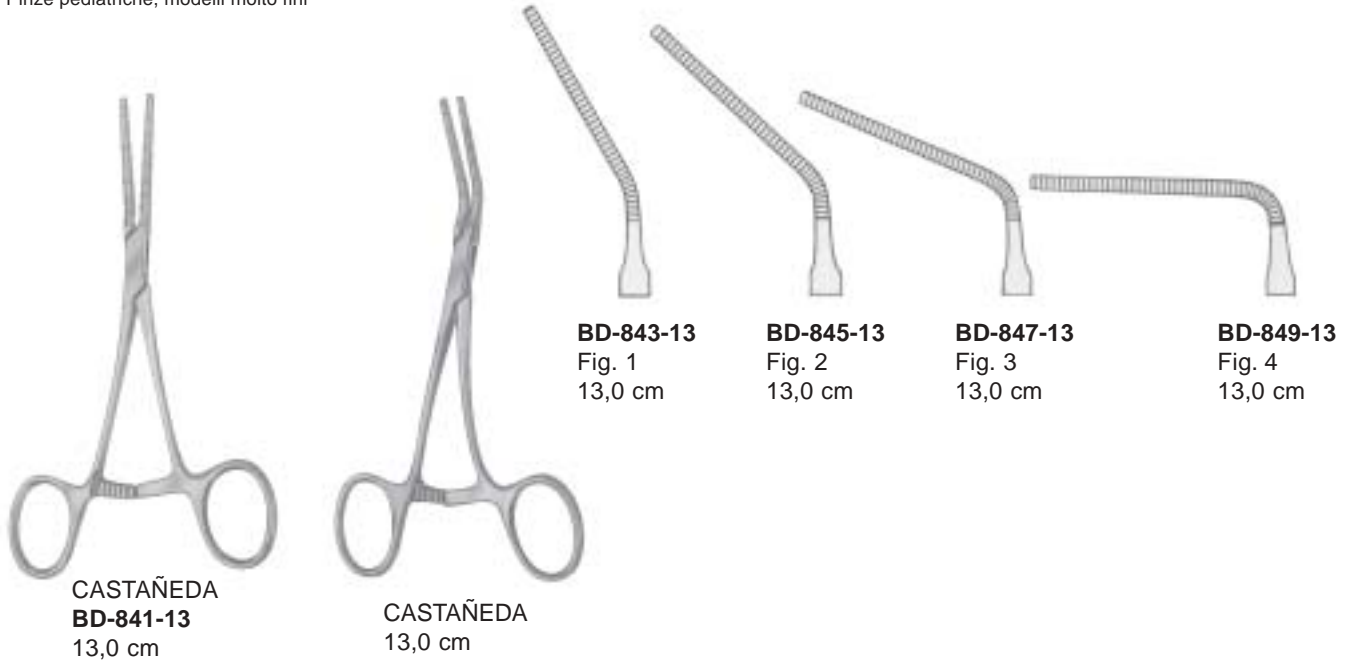

Kinder-Gefäßklemmen
 Pediatric Vascular Clamp
 Pincas vasculaires pédiatriques
 Pinzas vasculares pediátricas
 Pinze vascolari pediatriche



gerade
 straight
 droites
 rectas
 rette

BD-052-01 - BD-052-09
 Fig. 1-9



abgewinkelt
 angled
 coudées
 acodadas
 angolari

BD-053-01 - BD-053-09
 Fig. 1-9



stark abgewinkelt
 strongly angled
 fortement coudées
 fuertemente acodadas
 fortemente angolari

BD-055-01 - BD-055-09
 Fig. 1-9



Fig. 1
BD-052-01
BD-053-01
BD-055-01



Fig. 2
BD-052-02
BD-053-02
BD-055-02



Fig. 3
BD-052-03
BD-053-03
BD-055-03



Fig. 4
BD-052-04
BD-053-04
BD-055-04



Fig. 5
BD-052-05
BD-053-05
BD-055-05



Fig. 6
BD-052-06
BD-053-06
Bd-055-06



Fig. 7
BD-052-07
BD-053-07
BD-055-07



Fig. 8
BD-052-08
BD-053-08
BD-055-08



Fig. 9
BD-052-09
BD-053-09
BD-055-09

BD

Flexible Gefäßklemmen
Flexible Vessel Clamps
Pinces vasculaires flexibles
Pinzas vasculares flexibles
Pinze vascolari flessibili



BD-069-12 - BD-161-30
20,0 cm



BD-069-12
12 mm



BD-069-20
20 mm



BD-069-30
30 mm



BD-161-12
12 mm



BD-161-20
20 mm



BD-161-30
30 mm

Flexible Gefäßklemmen
Flexible Vessel Clamps
Pincas vasculaires flexibles
Pinzas vasculares flexibles
Pinze vascolari flessibili

BD



BD-165-03
ø 3 mm



BD-165-05
ø 5 mm



BD-165-07
ø 7 mm



BD-165-09
ø 9 mm

BD-165-03 - BD-165-09

BD